

CRASH SWITCH

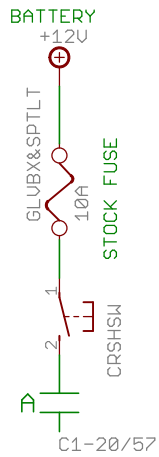

FUSE BLOCK WIRING

Using Cooper Bussman Series 15300 RTMR with 4 Micro Relays

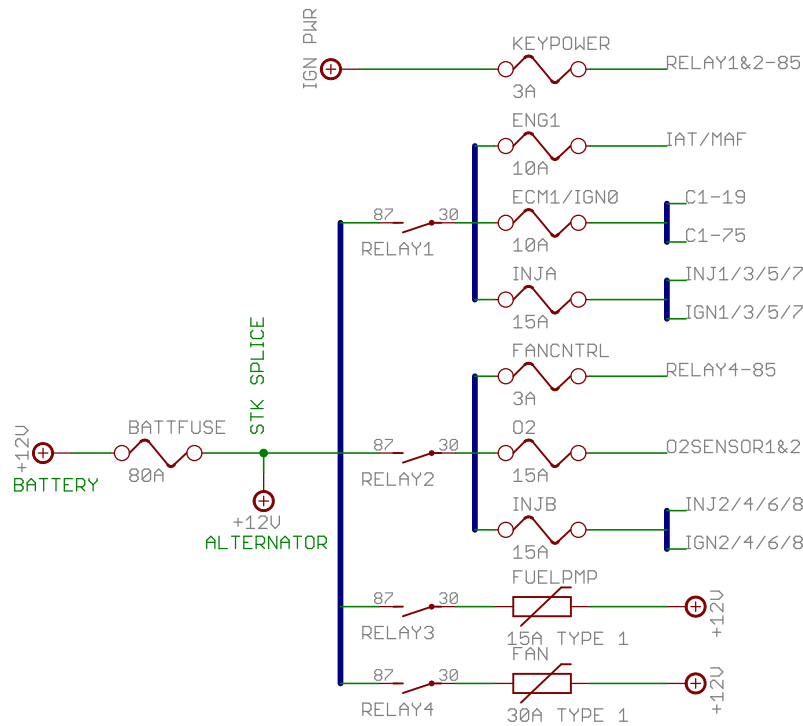

C1=PCM CONNECTOR 1 (BLUE)
C2=PCM CONNECTOR 2 (GREEN)

RELAY CONTROL

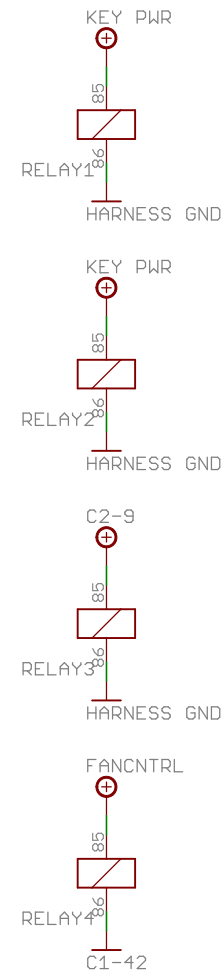

CONNECTORS

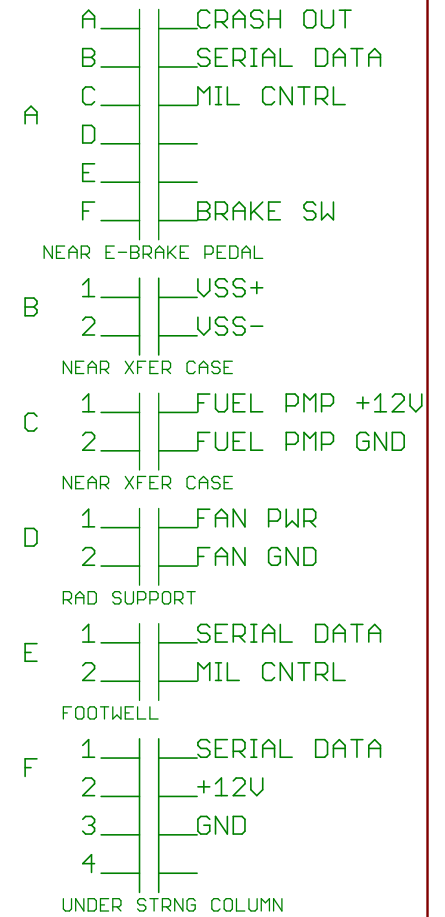

FUEL PUMP WIRING

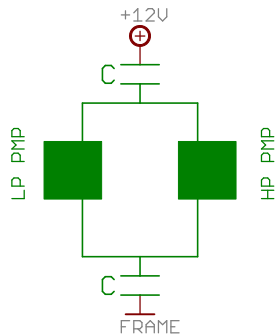

FAN WIRING

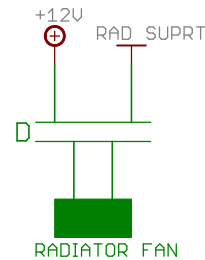

MIL WIRING

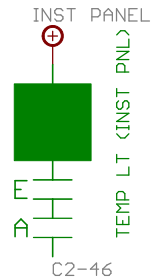

DTC WIRING

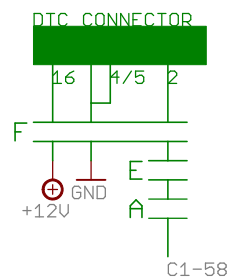

TITLE: 6.0L K-10 Vortec Retrofit Wiring

Document Number:

REV:

Date: 12/8/12 3:27 PM

Sheet: 1/1